

LF310 数据表

低流量减压阀



● 气体 ● 液体

● 隔膜感应

● 活塞

● 自排泄

● 无排泄

最大入口压力: 414 bar
(6,000 psi)

最大出口压力: 35 bar
(510 psi)

Cv 0.06



LF310 简介...

LF310 是一款单级隔膜感应压力调节阀，适用于除了延长生命周期外还需要更高入口供应压力的应用。基于 LF300，具有持久的 Inconel® X750 隔膜，LF310 还提供“实心盘”阀座设计对于侵蚀性或高温应用更加坚固。

规格

最大限度。额定入口压力	414 bar (6,000 psi)
出口压力范围	高达 35 bar (510 psi)
设计耐压	150%最大工作压力
阀座泄漏标准	符合 ANSI/FCI 70-3
重量	0.9kg (2lbs)

标准建筑材料

部分	材料
阀体和阀盖	ASTM A479 316/316L 不锈钢 (UNS S31600/S31603)
主阀销	ASTM A479 316/316L 不锈钢
软阀座	PEEK™ (450G) PCTFE (Kel-F)
主阀弹簧	铬镍铁合金® X750 (UNS N07750)
隔膜	铬镍铁合金® X750 (UNS N07750)
手轮	Nylon
O型圈	FKM/FPM (Viton)
加载弹簧	ASTM A240 301 不锈钢 (UNS S30100)
过滤网	40 Microns

注：压力调节器额定值可能受到连接类型、Cv 和/或阀座材料的限制。请联系办公室了解具体的压力或温度要求。

特点和优点

1 铬镍铁合金® X750 隔膜

增强度和使用寿命可靠性，适用于干净或腐蚀性介质应用。

2 316SS 螺纹阀盖

面板安装选项作为标准配置。

3 40微米入口过滤器

软阀座保护免受系统污染。

4 实心盘座椅设计

坚固的设计可实现高达 414 bar (6,000 psi) 的更高入口压力。

Product availability and specifications contained herein are subject to change without notice. Consult local distributor or factory for potential revisions and/or service related issues. Pressure Tech Ltd support with product selection recommendations only - it is the users responsibility to ensure the product is suitable for their specific application requirements.



PRESSURE TECH LTD

Unit 24, Graphite Way, Hadfield, Glossop, Derbyshire, UK, SK13 1QH

T +44 (0)1457 899 307

E sales@pressure-tech.com

W www.pressure-tech.com

英国设计、制造和建造

030225

PAGE:
1 OF 4

LF310 数据表

低流量减压阀



● 气体 ● 液体

● 隔膜感应

● 活塞

● 自排泄

● 无排泄

最大入口压力: 414 bar
(6,000 psi)

最大出口压力: 35 bar
(510 psi)

Cv 0.06

图纸和安装尺寸

显示的尺寸仅适用于 1/4" NPT 选项和标准配置 - 请联系办公室了解其他选项。

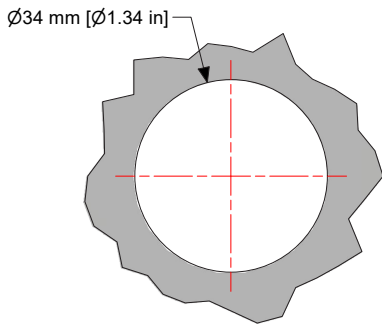
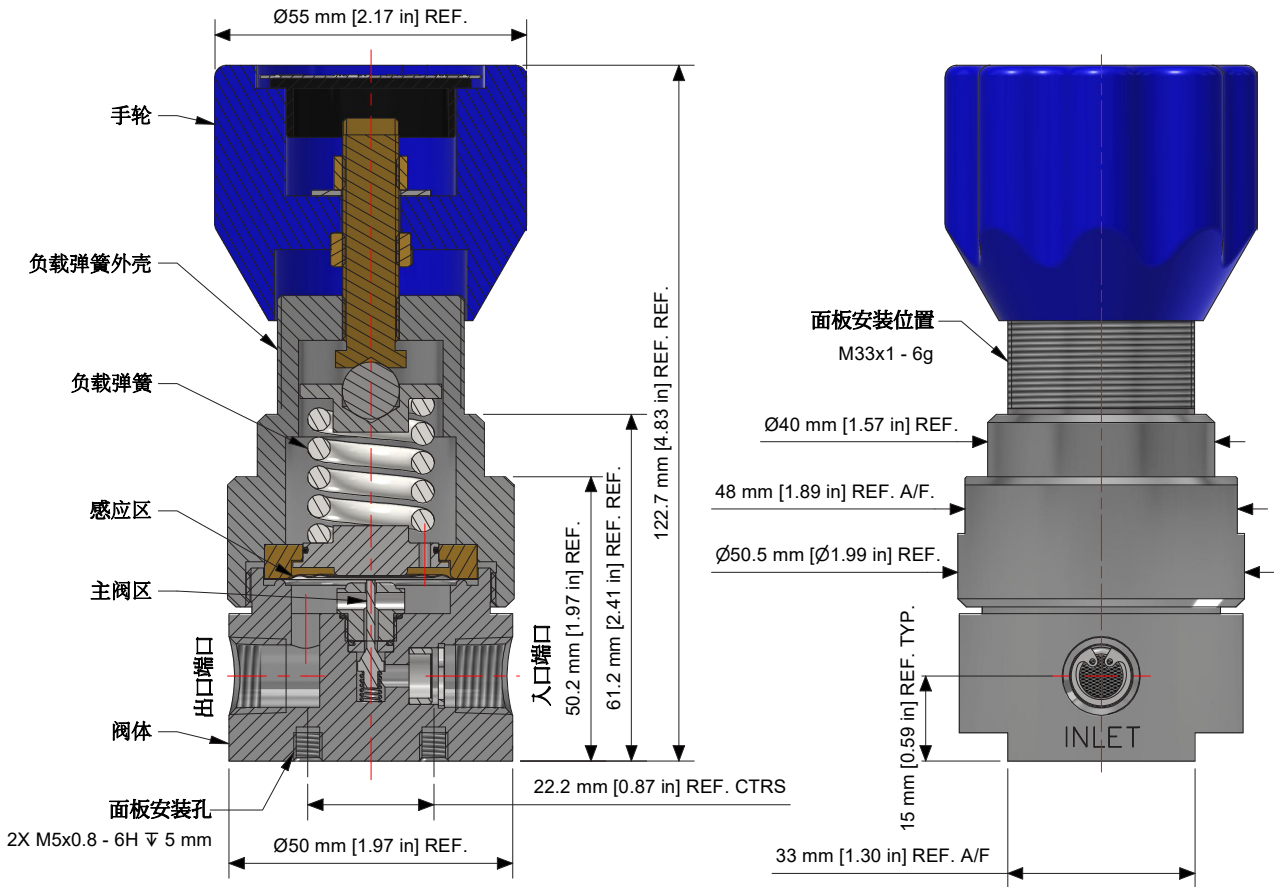

面板开孔

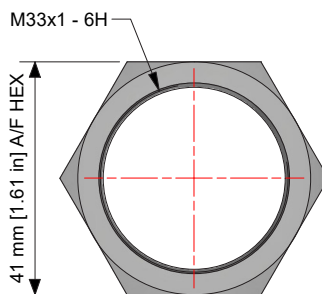

面板安装环
(PT-C-024)
不锈钢

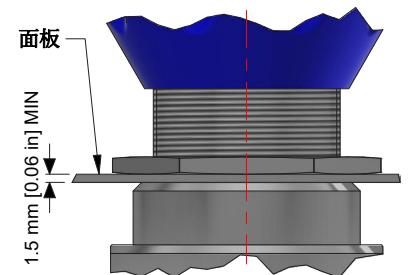

注: 所有压力表端口均采用 1/4" NPT 标准。

Product availability and specifications contained herein are subject to change without notice. Consult local distributor or factory for potential revisions and/or service related issues. Pressure Tech Ltd support with product selection recommendations only - it is the users responsibility to ensure the product is suitable for their specific application requirements.



PRESSURE TECH LTD

Unit 24, Graphite Way, Hadfield, Glossop, Derbyshire, UK, SK13 1QH

T +44 (0)1457 899 307

E sales@pressure-tech.com

W www.pressure-tech.com

英国设计、制造和建造

030225

PAGE:
2 OF 4

LF310 数据表

低流量减压阀

PRESSURE TECH

● 气体 ● 液体

● 隔膜感应 ● 活塞

● 自排泄 ● 无排泄

最大入口压力: 414 bar
(6,000 psi)

最大出口压力: 35 bar
(510 psi)

Cv 0.06

流量曲线

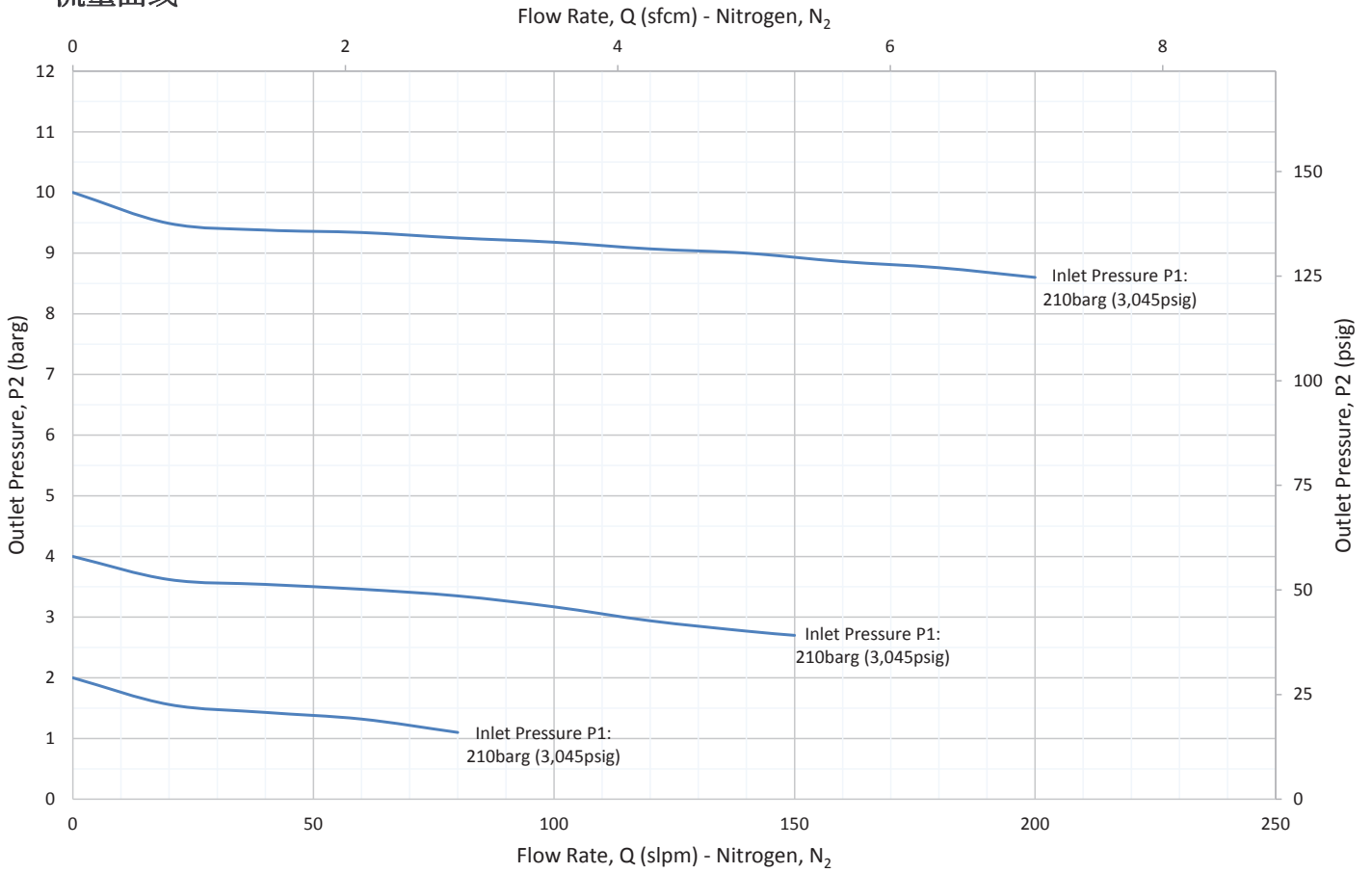

端口配置

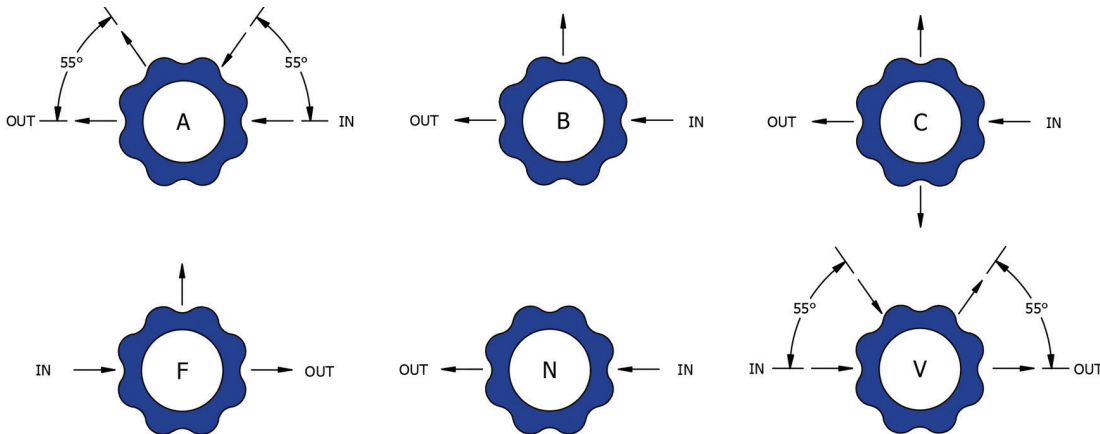

注意：可提供其他端口配置 - 请联系办公室了解更多信息。

Product availability and specifications contained herein are subject to change without notice. Consult local distributor or factory for potential revisions and/or service related issues. Pressure Tech Ltd support with product selection recommendations only - it is the users responsibility to ensure the product is suitable for their specific application requirements.



PRESSURE TECH LTD

Unit 24, Graphite Way, Hadfield, Glossop, Derbyshire, UK, SK13 1QH

T +44 (0)1457 899 307

E sales@pressure-tech.com

W www.pressure-tech.com

英国设计、制造和建造

030225

PAGE:
3 OF 4

LF310 数据表

低流量减压阀



● 气体 ● 液体

● 隔膜感应

● 活塞

● 自排泄

● 无排泄

最大入口压力: 414 bar
(6,000 psi)

最大出口压力: 35 bar
(510 psi)

Cv 0.06

订购信息

要构建PT零件号，只需按顺序组合下面标识的字符即可：

LF310 - 06 - S - 35 - P - N - XXX	
调节器型号/系列 LF310 - Low-Flow	定制代码* 请联系办公室了解更多信息。
CV VALUE 06 - 0.06 15 - 0.15 (max. inlet 50 bar/725 psi)	端口配置 N - 无仪表端口 有关端口选项，请参阅第3页。
主体材料** S - ASTM A479 316/316L 不锈钢 B - HT 黄铜 H - 哈氏合金® C276	主阀座材料** T - PTFE (最大入口压力 20 bar/290 psi) F - FEP (最大入口压力 50 bar/725 psi) K - PCTFE (最大入口压力 300 bar/4,350 psi) P - PEEK™ (最大入口压力 414 bar/6,000 psi)
出口控制压力 04 - 高达 4 bar (60 psi) 10 - 高达 10 bar (145 psi) 20 - 高达 20 bar (290 psi) 35 - 高达 35 bar (510 psi)	

额外选项

	零件编号	描述
维修套件	SRK-LF310-06-U-K-M2-V	PCTFE 阀座 and FKM/FPM O型圈
维修套件	SRK-LF310-06-U-P-M2-V	PEEK™ 阀座 and FKM/FPM O型圈
面板安装环	PT-C-024	-

注：可提供辅助设备和附加服务套件选项

TRADEMARKS: PEEK™ is a trademark of Victrex PLC
Inconel® is a registered trademark of Inco Alloys International
Hastelloy® is a registered trademark of Haynes International, Inc

* Where applicable
** Other materials may be available - please contact the office

Product availability and specifications contained herein are subject to change without notice. Consult local distributor or factory for potential revisions and/or service related issues.
Pressure Tech Ltd support with product selection recommendations only - it is the users responsibility to ensure the product is suitable for their specific application requirements.



PRESSURE TECH LTD
Unit 24, Graphite Way, Hadfield, Glossop, Derbyshire, UK, SK13 1QH
T +44 (0)1457 899 307
E sales@pressure-tech.com
W www.pressure-tech.com

英国设计、制造和建造

030225

PAGE:
4 OF 4